

3V-40V Vin, 150mA, 2.5uA Iq, Low-Dropout Regulator

FEATURES

- Wide Input Range: 3V-40V
- With up to 45V Transient Input Voltage
- Maximum Output Current: 150mA
- Output Voltage:
 - 3.3V and 5V (Fixed Output)
 - Other Output Voltage Options (Need contact SCT sales)
- Output Voltage Accuracy:
 - $T_J = 25^{\circ}\text{C} : \pm 1\%$
 - $T_J = -40^{\circ}\text{C} \sim 125^{\circ}\text{C} : \pm 2\%$
- Low Quiescent Current: 2.5uA
- Low Dropout Voltage :
 - 204mV at 50mA load current
 - 643mV at 150mA load current
- Support Output Capacitors Range:
 - 3.3uF~220uF
 - Low-ESR: 0.001Ω~ 5 Ω
- 660us Internal Soft-start Time
- Integrated Short-Circuit Protection with OCFB (Over Current Fold-back) Feature
- Over-Temperature Protection
- Available Package: SOT23-5 / SOT23-3 / SOT89-3

APPLICATIONS

- Handheld Devices with Battery Power Supply
- POS and Power Tools
- Meters and Smoke Detector
- Industrial Control

DESCRIPTION

The SCT71401 series products is a low-dropout linear regulator designed to operate with a wide input-voltage range from 3 V to 40 V (45V transient input voltage) and 150mA output current. The SCT71401 series products is stable with 3.3uF~220uF output capacitors, and 10uF ceramic capacitor is recommended.

Only 2.5-μA typical quiescent current at light load makes the SCT71401 series products ideal choices for portable devices with battery power supply and an optional solution for powering microcontrollers (MCUs) and CAN/LIN transceivers in always-on systems.

The SCT71401 series products integrated short-circuit and overcurrent protection with OCFB (Over Current Fold-back) feature, which makes the device more reliable during transient high-load current faults or shorting events.

The SCT71401 series products provide fixed 3.3V and 5V output voltage versions, and also could provide 1.2V, 1.8V, 2.5V, 3V, 4.2V and 4.5V fixed output voltage versions, please contact SCT sales if needed.

The SCT71401 series products is available in SOT23-5, SOT23-3, and SOT89-3 packages, for other package options, please contact SCT sales.

TYPICAL APPLICATION

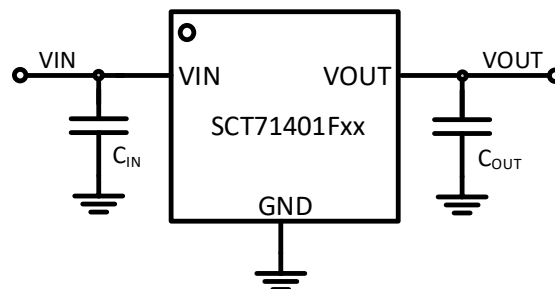

SCT71401 Series

REVISION HISTORY

NOTE: Page numbers for previous revisions may differ from page numbers in the current version.

Revision 1.0: Release to production.

Revision 1.1: Update the thermal information and the thermal characteristic.

Revision 1.2: Update the thermal information and the thermal characteristic.

Revision 1.3: Update the TAPE AND REEL INFORMATION.

DEVICE ORDER INFORMATION

Part Number	Output Voltage	Package	Package Marking	Transport Media, Quantity
SCT71401F50TWDR	Fixed 5.0V	SOT23-5	1F50	Tape & Reel, 3000
SCT71401F33TWDR	Fixed 3.3V	SOT23-5	1F33	Tape & Reel, 3000
SCT71401F50TYDR	Fixed 5.0V	SOT23-3	1F50	Tape & Reel, 3000
SCT71401F33TYDR	Fixed 3.3V	SOT23-3	1F33	Tape & Reel, 3000
SCT71401F50TYFR	Fixed 5.0V	SOT89-3	1F50	Tape & Reel, 3000
SCT71401F33TYFR	Fixed 3.3V	SOT89-3	1F33	Tape & Reel, 3000

PIN CONFIGURATION

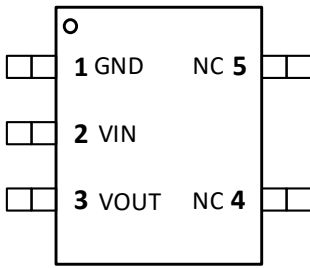

SCT71401FxxTWDR
SOT23-5 Package

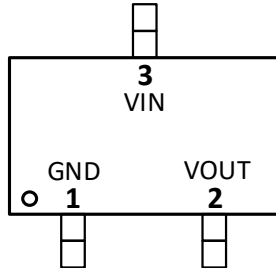

SCT71401FxxTYDR
SOT23-3 Package

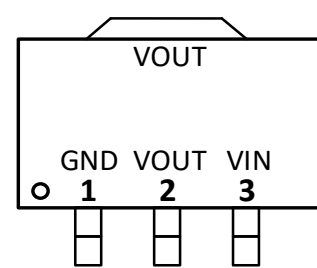

SCT71401FxxTYFR
SOT89-3 Package

PIN FUNCTIONS

SOT23-5/SCT71401Fxx:

PIN NUMBER	NAME	PIN FUNCTION
1	GND	Ground reference pin.
2	VIN	Input voltage pin
3	VOUT	Regulated output voltage pin
4	NC	No connection
5	NC	No connection

SOT23-3/SCT71401Fxx:

PIN NUMBER	NAME	PIN FUNCTION
1	GND	Ground reference pin.
2	VOUT	Regulated output voltage pin
3	VIN	Input voltage pin

SOT89-3/SCT71401Fxx:

PIN NUMBER	NAME	PIN FUNCTION
1	GND	Ground reference pin.
2	VOUT	Regulated output voltage pin
3	VIN	Input voltage pin

SCT71401 Series

RECOMMENDED OPERATING CONDITIONS

Over operating free-air temperature range unless otherwise noted

PARAMETER	DEFINITION	MIN	MAX	UNIT
V _{IN}	Input voltage range	3	40	V
V _{OUT}	Output voltage range	1.2	5	V
C _{IN}	Input capacitor	2.2	--	uF
C _{OUT}	Output capacitor	3.3	220	uF
ESR	Output capacitor ESR requirements	0.001	5	Ω
T _A	Operating ambient temperature	-40	125	°C
T _J	Operating junction temperature	-40	125	°C

ABSOLUTE MAXIMUM RATINGS

Over operating free-air temperature range unless otherwise noted ⁽¹⁾

PARAMETER	DEFINITION	MIN	MAX	UNIT
V _{IN} ⁽¹⁾	Maximum input voltage range	-0.3	45	V
V _{OUT}	Maximum output voltage range	-0.3	5.5	V
T _J ⁽²⁾	Junction temperature range	-40	150	°C
T _{stg}	Storage temperature range	-65	150	°C

- (1) Stresses beyond those listed under Absolute Maximum Rating may cause device permanent damage. The device is not guaranteed to function outside of its Recommended Operation Conditions.
- (2) The IC includes over temperature protection to protect the device during overload conditions. Junction temperature will exceed 150°C when over temperature protection is active. Continuous operation above the specified maximum operating junction temperature will reduce lifetime.

ESD RATINGS

PARAMETER	DEFINITION	MIN	MAX	UNIT
V _{ESD}	Human Body Model(HBM), per ANSI-JEDEC-JS-001-2014 specification, all pins ⁽¹⁾	-7	+7	kV
	Charged Device Model(CDM), per ANSI-JEDEC-JS-002-2014 specification, all pins ⁽²⁾	-1	+1	kV

- (1) JEDEC document JEP155 states that 500V HBM allows safe manufacturing with a standard ESD control process.
- (2) JEDEC document JEP157 states that 250V CDM allows safe manufacturing with a standard ESD control process.

THERMAL INFORMATION

The value of $R_{\theta JA}$ and $R_{\theta JC}$ given in this table is only valid for comparison with other packages and cannot be used for design purposes. Because they were simulated in accordance with JESD 51-7. They do not represent the performance obtained in an actual application. For design information see Power Dissipation and Thermal Performance section.

The value of $R_{\theta JA_EVM}$ is the tested results based on our EVM, and is more useful for thermal design. Even if it still do not represent the thermal performance of customer's PCB design, but it was a good starting point for thermal performance design.

The PCB information of our EVM: 2-layer, 1oz Cu, 50mm x 30mm size.

The values given in this table are not a characteristic of package itself, but of many other system level characteristics such as the design and layout of the printed circuit board (PCB), thermal pad size, and external environmental factors. The PCB board is a heat sink that is soldered to the leads and thermal pad of the device. Changing the design or configuration of the PCB board changes the efficiency of the heat sink and therefore the actual values of the below table.

Package Type	$R_{\theta JA}^{(1)}$	$R_{\theta JC}^{(2)}$	$R_{\theta JA_EVM}^{(3)}$	UNIT
SOT23-5	213.45	167.56	103.81	°C/W
SOT23-3	252.03	170.99	112.18	
SOT89-3	120.4	193.96	122.8	

(1) $R_{\theta JA}$ is junction to ambient thermal resistance, based on JESD51-7.

(2) $R_{\theta JC}$ is junction to case thermal resistance, based on JESD51-7.

(3) $R_{\theta JA_EVM}$ is junction to ambient thermal resistance, which is tested on SCT EVM.

SCT71401 Series

ELECTRICAL CHARACTERISTICS

$V_{IN}=V_{OUT}+1V$, $C_{OUT}=10\mu F$, $T_J=-40^{\circ}C\sim 125^{\circ}C$, typical value is tested under $25^{\circ}C$.

SYMBOL	PARAMETER	TEST CONDITION	MIN	TYP	MAX	UNIT
Power Supply						
V_{IN}	Operating input voltage		3		40	V
V_{UVLO}	V_{IN} UVLO Threshold	V_{IN} rising	2.3	2.64	2.9	V
	Hysteresis			210		mV
I_Q	Quiescent current from GND pin	No load, $V_{IN}=V_{OUT}+1V$		2.5		μA
		No load, $V_{IN}=12V$		2.6		μA
Regulated Output Voltage and Current						
V_{OUT}	Output voltage accuracy	$T_J=25^{\circ}C$	-1%		1%	
		$T_J=-40^{\circ}C\sim 125^{\circ}C$	-2%		2%	
ΔV_{OUT}	Line regulation	$V_{IN}=V_{OUT}+1V$ to 40V, or $V_{IN}>3V$, $I_{OUT}=10mA$		4.5	10	mV
	Load regulation	$I_{OUT}=1mA$ to 150mA		5	20	mV
V_{DROP}	Dropout voltage ⁽¹⁾	$V_{IN}=V_{OUT}-0.1V$, $I_{OUT}=50mA$		204		mV
		$V_{IN}=V_{OUT}-0.1V$, $I_{OUT}=100mA$		416		mV
		$V_{IN}=V_{OUT}-0.1V$, $I_{OUT}=150mA$		643		mV
I_{OUT}	Output current	V_{OUT} in regulation	0		150	mA
I_{SC_VINLOW}	Short current limit	$V_{OUT}=0V$, $V_{IN}<30V$		300		mA
$I_{SC_VINHIGH}$	Short current limit	$V_{OUT}=0V$, $V_{IN}>30V$		100		mA
PSRR	Power supply rejection ratio ⁽²⁾	$I_{OUT}=10mA$, $f=1kHz$, $C_{OUT}=10\mu F$		63		dB
		$I_{OUT}=10mA$, $f=10kHz$, $C_{OUT}=10\mu F$		43		dB
		$I_{OUT}=10mA$, $f=100kHz$, $C_{OUT}=10\mu F$		52		dB
Soft-startup						
T_{SS}	Soft-start time			660		μs
Thermal Protection						
T_{SD}	Thermal shutdown threshold ⁽³⁾	T_J rising		170		$^{\circ}C$
		Hysteresis		20		$^{\circ}C$

(1) The dropout voltage is defined as $V_{IN}-V_{OUT}$, when force V_{IN} is 100mV below the value of V_{OUT} for $V_{IN}=V_{OUT(NOM)}+1V$.

(2) PSRR is derived from bench characterization, not production test.

(3) Thermal shutdown threshold is derived from bench characterization, not production test.

TYPICAL CHARACTERISTICS

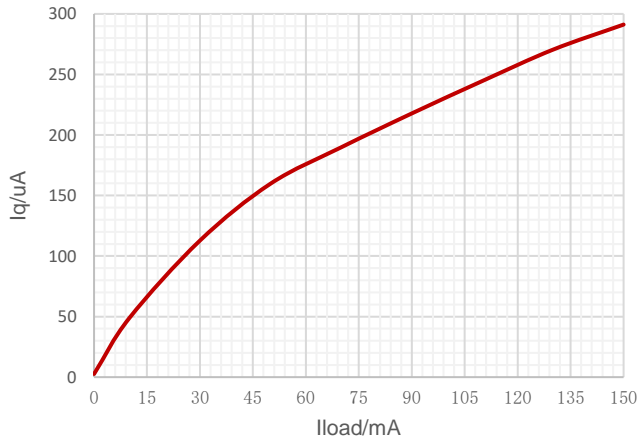

Figure 1. Quiescent Current vs Output Current

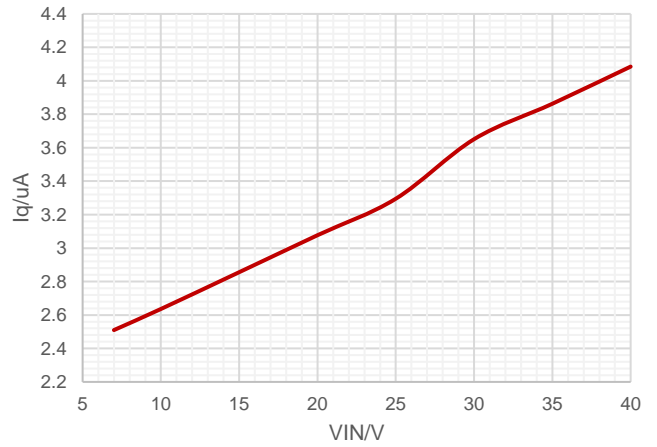

Figure 2. Quiescent Current vs Input Voltage, No load

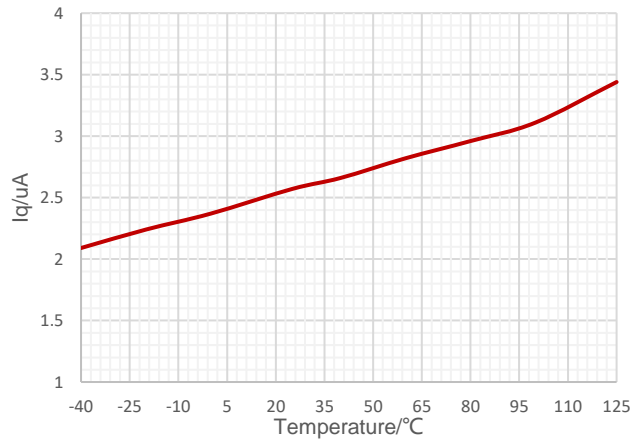

Figure 3. Quiescent Current vs Ambient Temperature

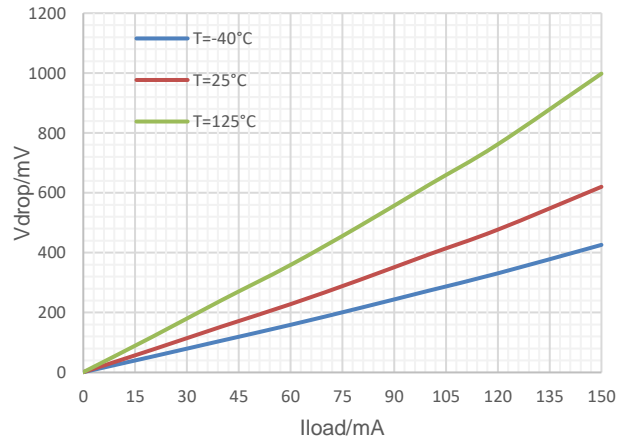

Figure 4. Dropout Voltage vs Output Current

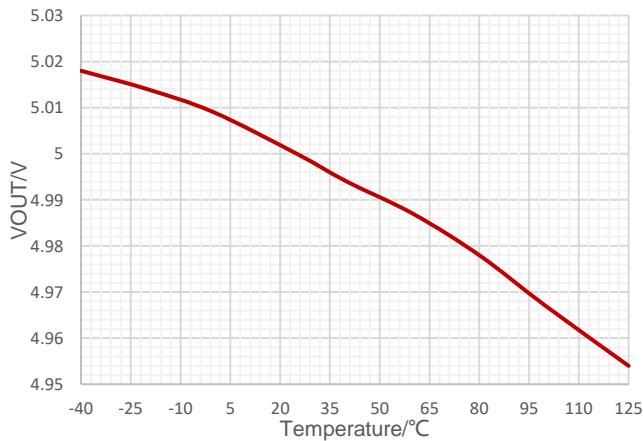

Figure 5. Output Voltage vs Ambient Temperature at VOUT=5V

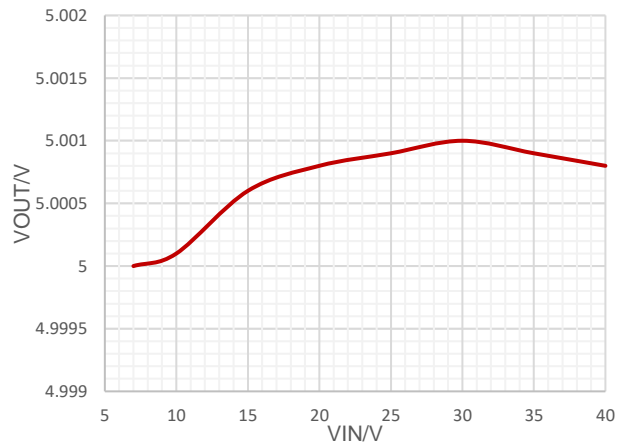

Figure 6. Output Voltage vs Input Voltage

SCT71401 Series

TYPICAL CHARACTERISTICS (continued)

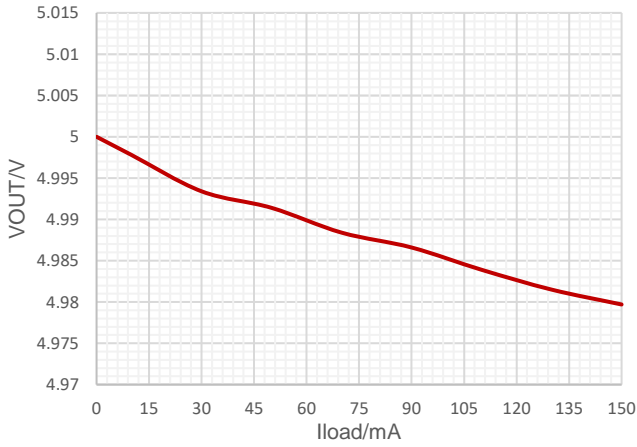

Figure 7. Output Voltage vs Output Current at VOUT=5V

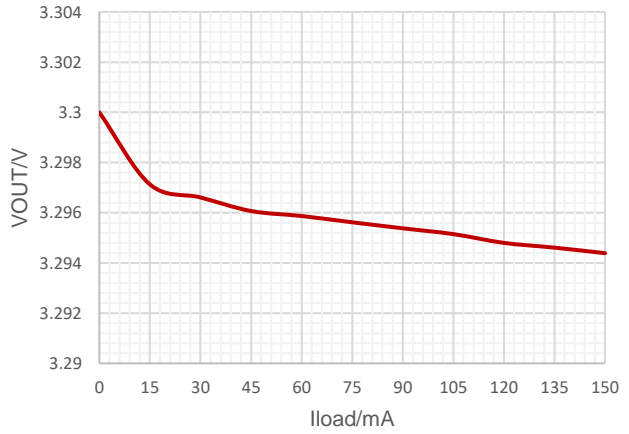

Figure 8. Output Voltage vs Output Current at VOUT=3.3V

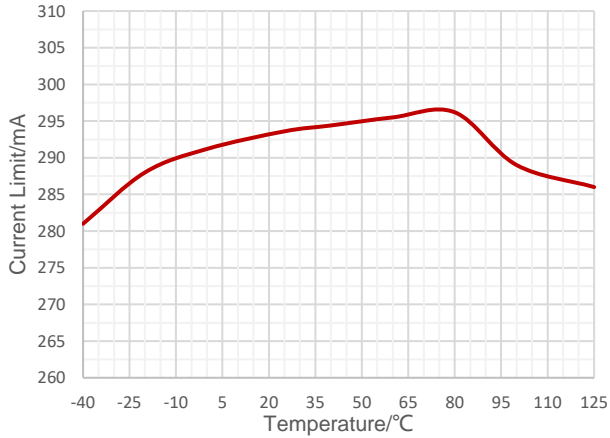

Figure 9. Output Current Limit vs Ambient Temperature at VIN<30V

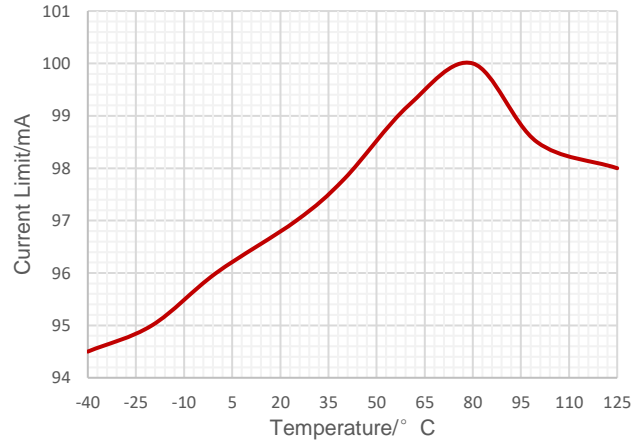

Figure 10. Output Current Limit vs Ambient Temperature at VIN≥30V

TYPICAL CHARACTERISTICS (continued)

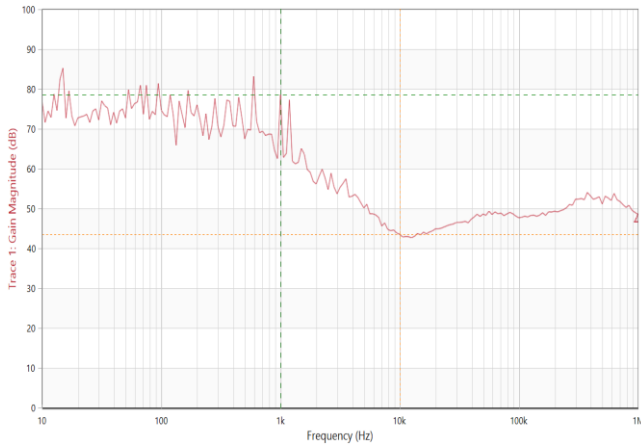

Figure 11. PSRR vs Frequency at $I_{out}=10\text{mA}$, $C_{OUT}=4.7\mu\text{F}$

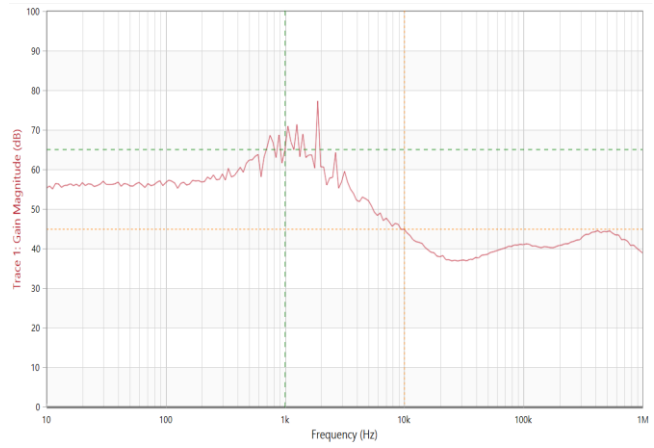

Figure 12. PSRR vs Frequency at $I_{out}=100\text{mA}$, $C_{OUT}=4.7\mu\text{F}$

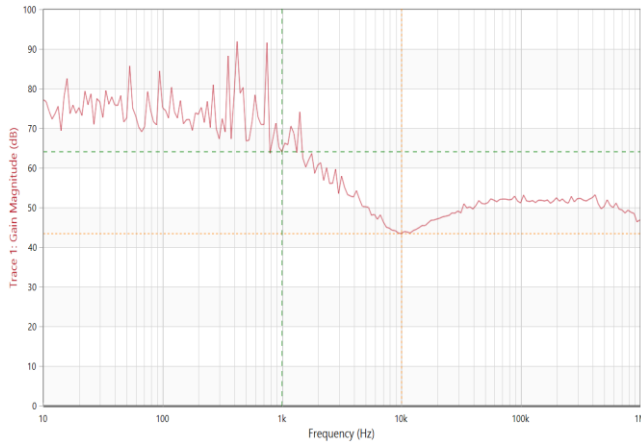

Figure 13. PSRR vs Frequency at $I_{out}=10\text{mA}$, $C_{OUT}=10\mu\text{F}$

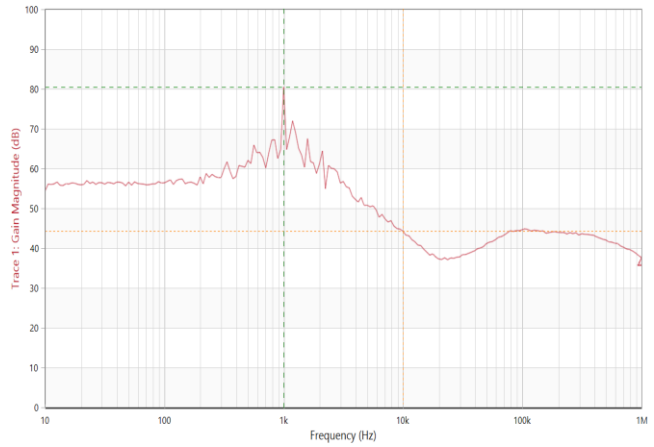

Figure 14. PSRR vs Frequency at $I_{out}=100\text{mA}$, $C_{OUT}=10\mu\text{F}$

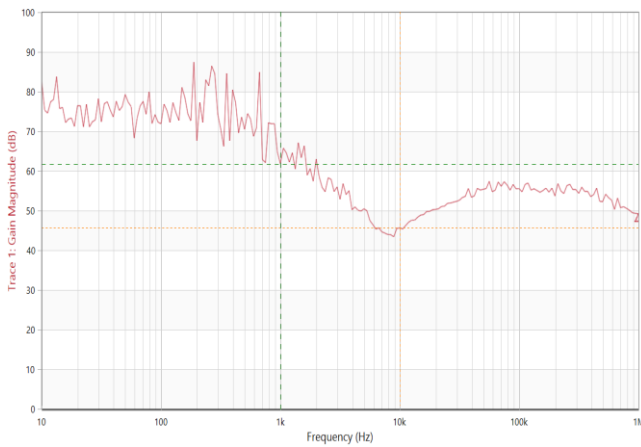

Figure 15. PSRR vs Frequency at $I_{out}=10\text{mA}$, $C_{OUT}=22\mu\text{F}$

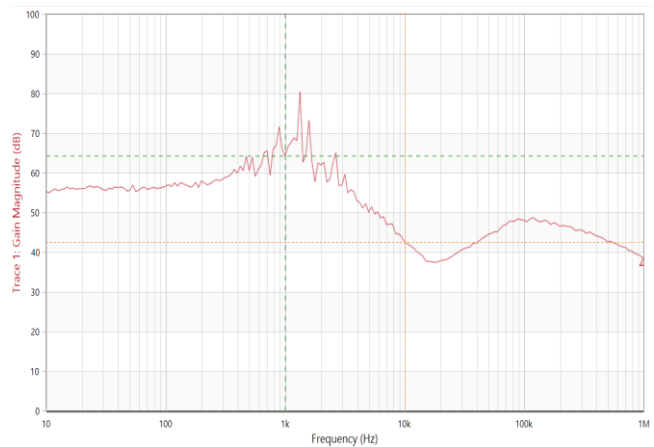

Figure 16. PSRR vs Frequency at $I_{out}=100\text{mA}$, $C_{OUT}=22\mu\text{F}$

FUNCTIONAL BLOCK DIAGRAM

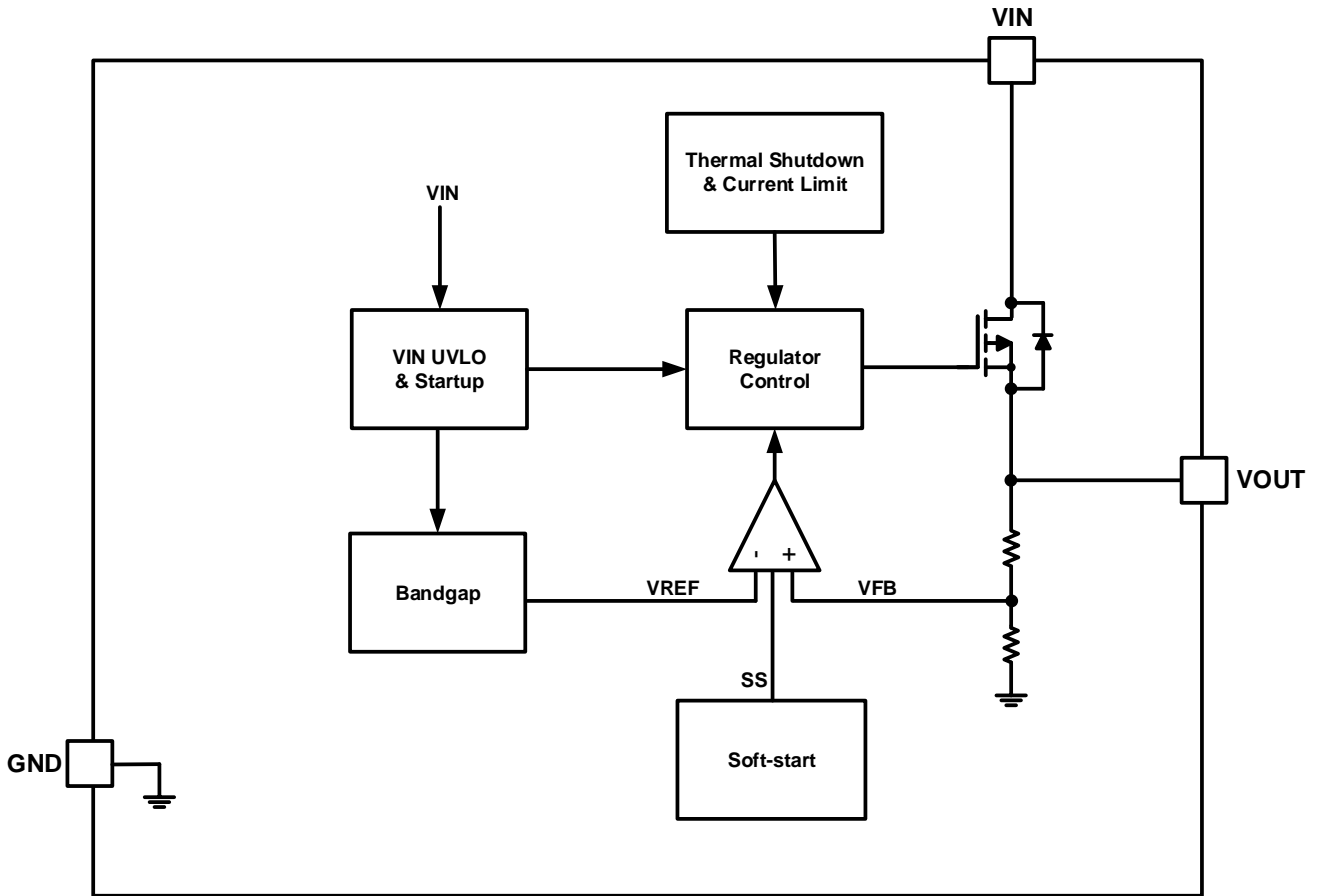

Figure 17. Functional Block Diagram

OPERATION

Overview

The SCT71401 series products are 150mA wide input voltage range linear regulators with very low quiescent current. These voltage regulators operate from 3V to 40V DC input voltage with supporting 45V transient input voltage and consume 2.5µA quiescent current at no load.

The SCT71401 series products is stable with 3.3µF~220µF output capacitors, and 10µF ceramic capacitor is recommended. An internal 660us soft-start time avoids large inrush current and output voltage overshoot during startup.

The SCT71401 series products also provide the VIN input under-voltage lockout, over current protection, output hard short protection and thermal shutdown protection.

The SCT71401 series products are available in fixed voltage versions of 3.3V and 5V with 1% output voltage accuracy at room temp and 2% output voltage accuracy over operating conditions. The series products are available in SOT23-5, SOT23-3 and SOT89-3 packages.

Regulated Output Voltage

The SCT71401 series are available in fixed voltage versions of 3.3V and 5V. When the input voltage is higher than $V_{OUT(NOM)} + V_{DROP}$, output pin is the regulated output based on the selected voltage version. When the input voltage falls below $V_{OUT(NOM)} + V_{DROP}$, output pin tracks the input voltage minus the dropout voltage based on the load current. When the input voltage drops below UVLO threshold, the output keeps shut off.

The SCT71401 series products also could provide other fixed output voltage versions of 1.2V, 1.8V, 2.5V, 3V, 4.2V and 4.5V and other package options. Please feel free to contact SCT sales, if you need a new output voltage version or a new package option.

Over Current Limit and Foldback Current Limit

The SCT71401 series products has an internal current limit circuit that protects the regulator during transient high-load current faults or shorting events. The current limit is 300mA when $V_{IN} < 30V$, but SCT71401 supplies a foldback current limit 100mA when $V_{IN} > 30V$.

The output voltage is not regulated when the device is in current limit. When a current limit event occurs, the regulator begins to heat up because of the increase in power dissipation. If thermal shutdown is triggered, the device turns off. After the device cools down, the internal thermal shutdown circuit turns the device back on. If the output current fault condition persists, the device cycles between current limit and thermal shutdown.

With the over current foldback limit feature, the SCT71401 series products would be more robust and safer when over current faults and shorting events occur. But it also requires the maximum loading current should be smaller than I_{sc} during startup. The characteristic is shown in the following figure.

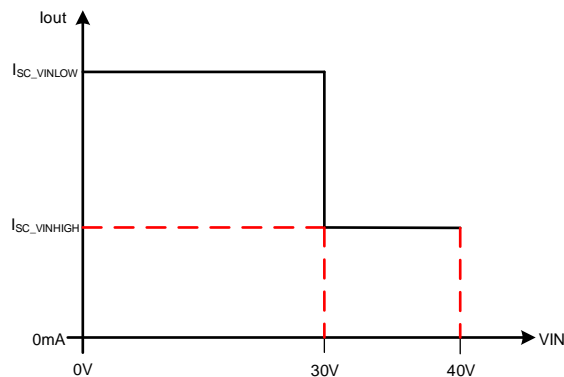

Figure 18. Current Limit with Foldback Feature

SCT71401 Series

Internal Soft-Start

The SCT71401 series products integrates an internal soft-start circuit that ramps the reference voltage from zero volts to 0.6V reference voltage in 660us. The soft-start will reset during shutdown due to thermal overloading.

Below figure shows the startup waveform at small output capacitor and large output capacitor. When output capacitor is small, for example 10uF, the slope of VOUT is limited by soft-start. When output capacitor is large, for example 100uF, the slope of VOUT is limited by current limit (I_{SC_VINLOW}) at $V_{IN} < 30V$, and the slope of VOUT is limited by current limit ($I_{SC_VINHIGH}$), when $V_{IN} > 30V$.

In SCT71401 series products, typical T_{SS} is 660us, and typical I_{SC_VINLOW} is 300mA and typical $I_{SC_VINHIGH}$ is 100mA, could use the following formula for initial startup time calculation.

$$T_{start} = \max \left\{ \frac{C_{OUT} \times V_{OUT}}{(I_{SC} - I_{load})}, T_{SS} \right\} \quad (1)$$

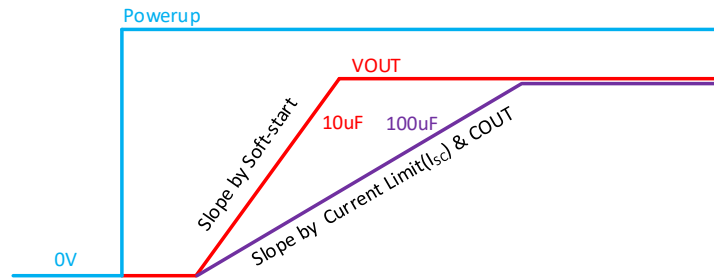

Figure 19. Soft-start Waveform vs Output Capacitor

Thermal Shutdown

This device incorporates a thermal shutdown (T_{SD}) circuit as a protection from overheating. For continuous normal operation, the junction temperature should not exceed the T_{SD} trip point. The junction temperature exceeding the T_{SD} trip point causes the output to turn off. When the junction temperature falls below the T_{SD} trip point minus thermal shutdown hysteresis, the output turns on again.

APPLICATION INFORMATION

Typical application 1:

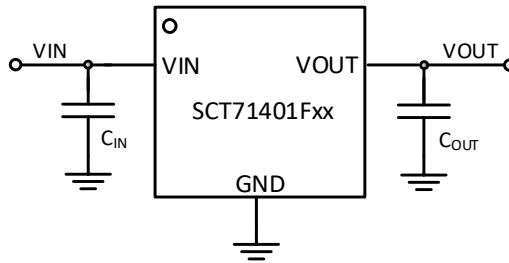

Figure 20. SCT71401 Typical Application Schematic

Design Parameters

Design Parameters	Example Value
Input Voltage	12V Normal, 5.5V~40V
Output Voltage	5V or 3.3V
Maximum Output Current	150mA
Output Capacitor Range (C_{OUT})	3.3uF~22uF , recommends 10uF
Input Capacitor Range (C_{IN})	>2.2uF , recommends 10uF

Typical application 2:

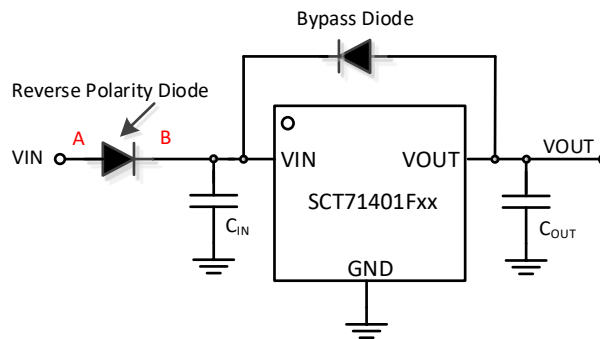

Figure 21. SCT71401 Typical Application Schematic with Reverse Polarity Diode

Design Parameters

Design Parameters	Example Value
Input Voltage	12V Normal, 5.5V~40V
Output Voltage	5V or 3.3V
Maximum Output Current	150mA
Output Capacitor Range (C_{OUT})	3.3uF~22uF , recommends 10uF
Input Capacitor Range (C_{IN})	>2.2uF , recommends 10uF

SCT71401 Series

In some applications, the VIN and the VOUT potential might be reversed, possibly resulting in circuit internal damage or damage to the elements. For example, the accumulated charge in the output pin capacitor flowing backward from the VOUT to the VIN when the VIN shorts to the GND. In order to minimize the damage in such case, use a capacitor with a capacitance less than 220 μ F. Also by inserting a reverse polarity diode in series to the VIN, it can prevent reverse current from reverse battery connection or the case, when the point A is short-circuited GND. If there may be any possible case point B is short-circuited to GND, we also recommend using a bypass diode between the VIN and the VOUT.

Typical application 3:

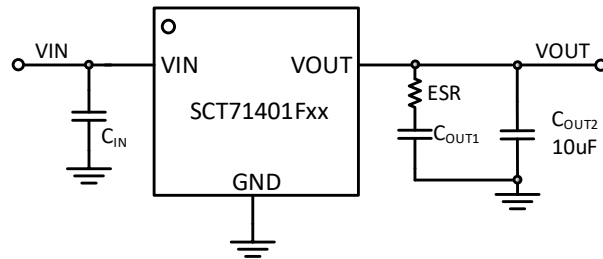

Figure 22. SCT71401 Typical Application Schematic with Large Output Capacitor

Design Parameters

Design Parameters	Example Value
Input Voltage	12V Normal, 5.5V~40V
Output Voltage	5V or 3.3V
Maximum Output Current	150mA
Output Capacitor Range (C _{OUT1} and ESR)	3.3 μ F~220 μ F with ESR=0.5 Ω ~5 Ω
Output Capacitor Range (C _{OUT2})	recommends 10 μ F with low ESR
Input Capacitor Range (C _{IN})	>2.2 μ F , recommends 10 μ F

Input Capacitor and Output Capacitor

SCT recommends adding a 2.2 μ F or greater capacitor with a 0.1 μ F bypass capacitor in parallel at VIN pin to keep the input voltage stable. Aluminum electrolytic capacitor or other capacitor with high capacitance is suggested for the system power with large voltage spike. The voltage rating of the capacitors must be greater than the maximum input voltage.

To ensure loop stability, the SCT71401 series products requires an output capacitor with a minimum effective capacitance value of 3.3 μ F. And the series products could support output capacitor range from 3.3 μ F to 220 μ F and with an ESR range between 0.001 Ω and 5 Ω . SCT recommends selecting a X5R- or X7R-type 4.7 μ F~10 μ F ceramic capacitor with low ESR over temperature range to improve the load transient response.

When using large output capacitor with higher ESR resistor, for example 100 μ F output electrolytic capacitor with 1 Ω ESR resistor in the application, SCT recommends adding extra 10 μ F low ESR output capacitor parallel connection with the large electrolytic capacitor, this will eliminate the undershoot/overshoot voltage caused by the large ESR resistor and get better load transient performance.

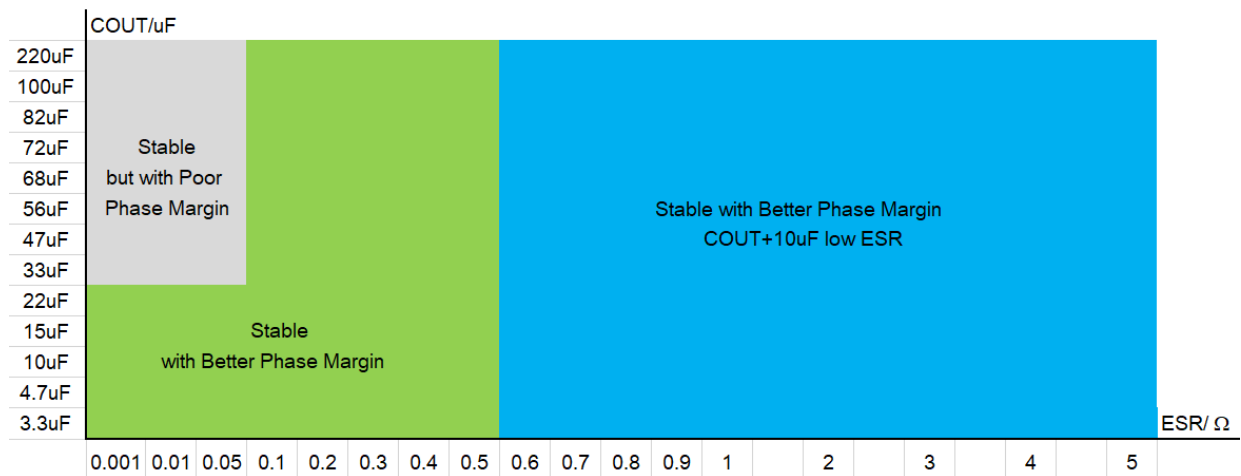

Figure 23. SCT71401 Stability vs Output Capacitor

SCT71401 Series

Power Dissipation and Thermal Performance

Power dissipation caused by voltage drop across the LDO and by the output current flowing through the device needs to be dissipated out from the chip. The maximum junction temperature is dependent on power dissipation, package, the PCB layout, number of used Cu layers, Cu layers thickness and the ambient temperature.

During normal operation, LDO junction temperature should not exceed 150°C, or else it may result in deterioration of the properties of the chip. Using below equations to calculate the power dissipation and estimate the junction temperature.

The power dissipation can be calculated using Equation 2. Because $I_{GND} \ll I_{OUT}$, the term $V_{IN} \times I_{GND}$ in Equation 2 could be ignored.

$$P_D = (V_{IN} - V_{OUT}) \times I_{OUT} + V_{IN} \times I_{GND} \quad (2)$$

The junction temperature can be estimated using Equation 3. $R_{\theta JA_EVM}$ is the junction-to-ambient thermal resistance based on customer's PCB. Verify the application and allow sufficient margins in the thermal design by the following method is used to calculate the junction temperature T_J .

$$T_J = T_A + P_D \times R_{\theta JA_EVM} \quad (3)$$

$R_{\theta JA_EVM}$ is a critical parameter and depends on many factors such as the following:

- Power dissipation
- Air temperature/flow
- PCB area
- Copper heat-sink area
- Number of thermal vias under the package
- Adjacent component placement

For the SCT71401 series products, the maximum allowable power dissipation of different packages was listed in the following table, and the test results are based on our EVM board, larger power dissipation will trigger thermal shutdown protection. As a result, we could calculate the $R_{\theta JA_EVM}$ of different packages. The following table is just for your reference based on our EVM test, please leave enough margin when you design thermal performance.

The PCB information of our EVM: 2-layer, 1oz Cu, 50mm x 30mm size.

Thermal Performance of Different Packages Based on EVM Test

Package	Max Allowable PD (W) (Not Trigger TSD, VOUT=5V)	Max Allowable PD (W) (T _J ≤125°C)	R _{θJA_EVM} (°C/W)
SOT23-5	1.397	0.963	103.81
SOT23-3	1.293	0.891	112.18
SOT89-3	1.181	0.81	122.78

THERMAL CHARACTERISTICS

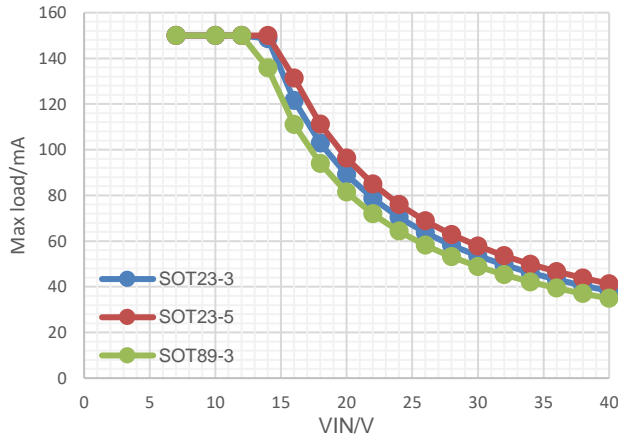

Figure 24. Maximum Output Current vs Input Voltage, VOUT=5V of Different Packages, $T_J \leq TSD_R$

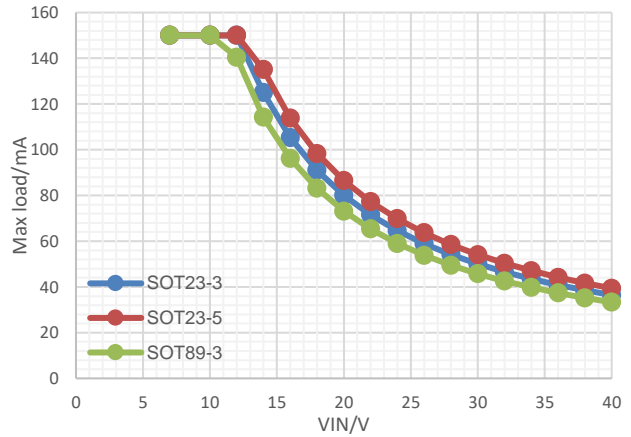

Figure 25. Maximum Output Current vs Input Voltage, VOUT=3.3V of Different Packages, $T_J \leq TSD_R$

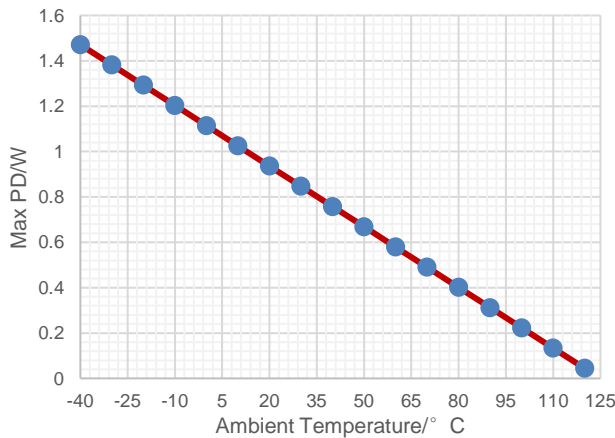

Figure 26. Maximum Allowed Power Dissipation vs Ambient Temperature, SOT23-3, $T_J \leq 125^\circ\text{C}$

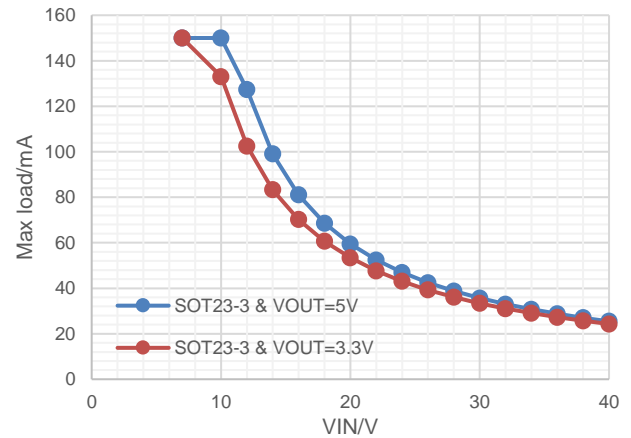

Figure 27. Maximum Output Current vs Input Voltage, SOT23-3, $T_J \leq 125^\circ\text{C}$

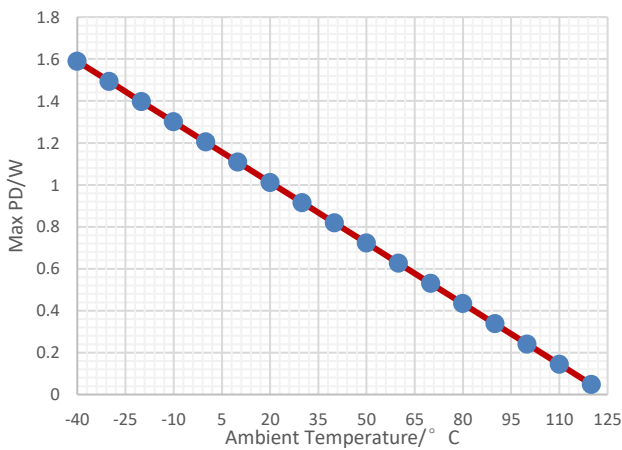

Figure 28. Maximum Allowed Power Dissipation vs Ambient Temperature, SOT23-5, $T_J \leq 125^\circ\text{C}$

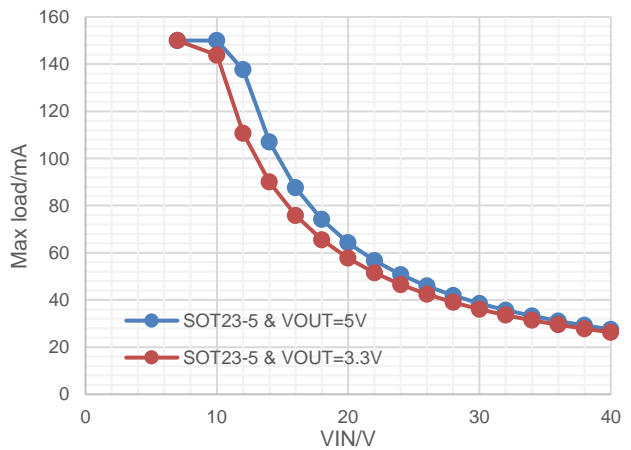

Figure 29. Maximum Output Current vs Input Voltage, SOT23-5, $T_J \leq 125^\circ\text{C}$

SCT71401 Series

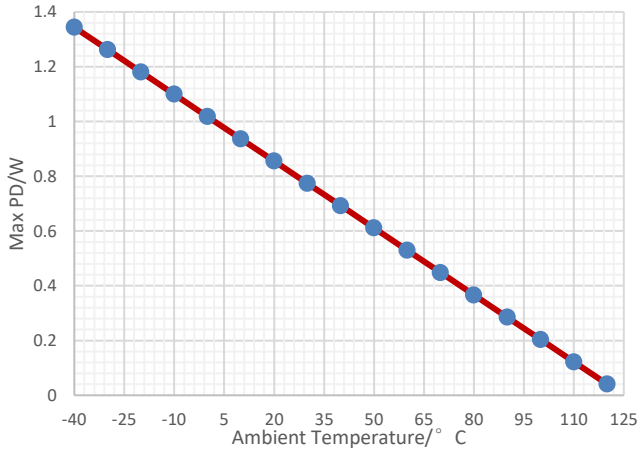

Figure 30. Maximum Allowed Power Dissipation vs Ambient Temperature, SOT89-3, $T_J \leq 125^\circ\text{C}$

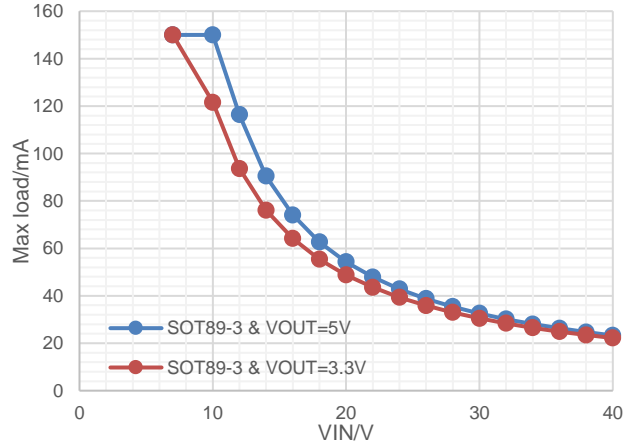

Figure 31. Maximum Output Current vs Input Voltage, SOT89-3, $T_J \leq 125^\circ\text{C}$

Application Waveforms

Vin=Vout +1V, unless otherwise noted

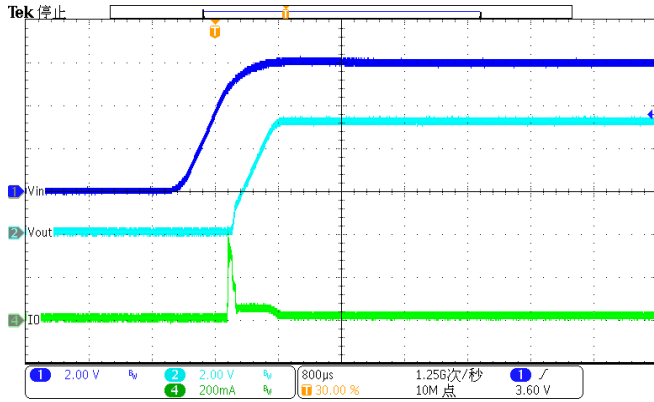

Figure 32. Power up (Iload=10mA)

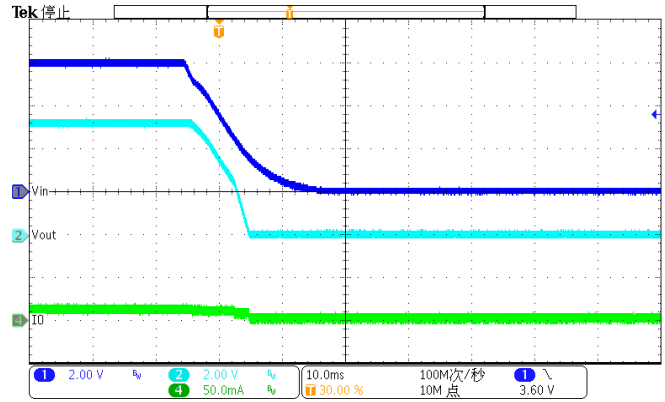

Figure 33. Power down (Iload=10mA)

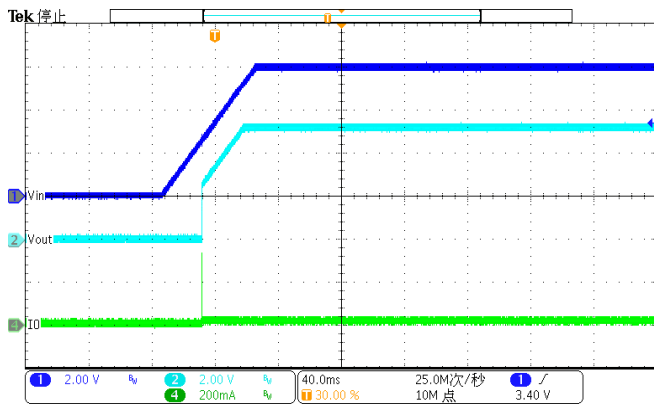

Figure 34. Slow Power up (Iload=10mA)

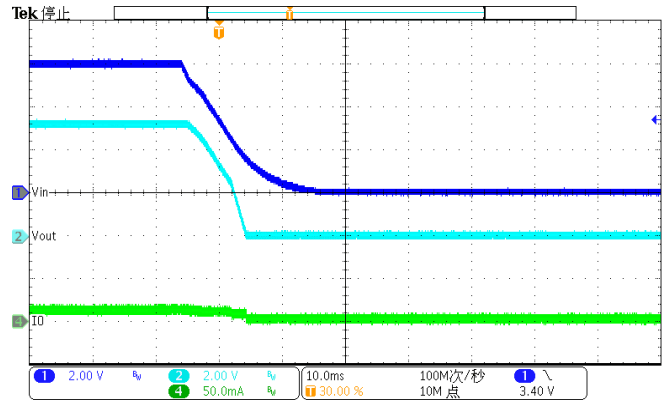

Figure 35. Slow Power down (Iload=10mA)

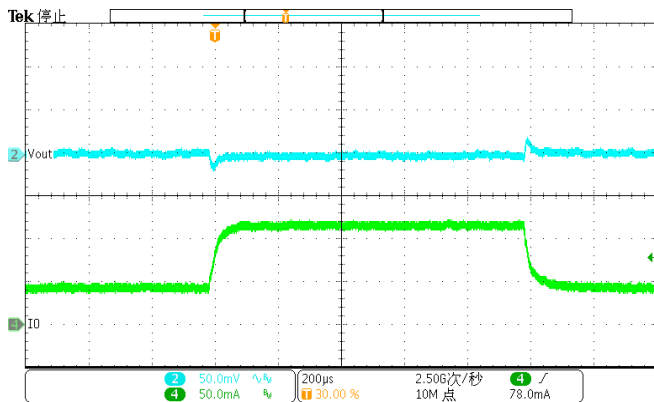

Figure 36. DC-DC Load Transient
(40mA-110mA), VOUT=5V

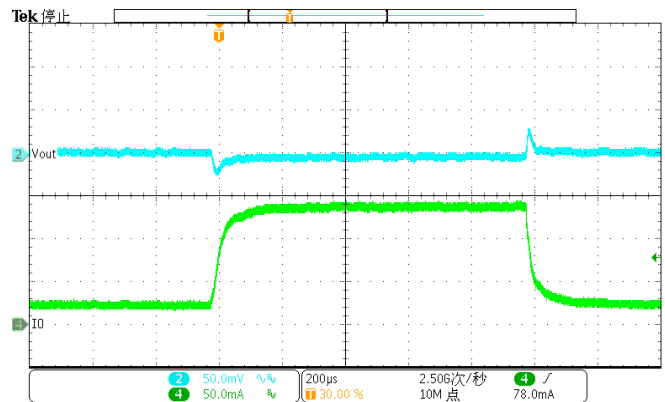

Figure 37. DC-DC Load Transient
(20mA-130mA), VOUT=5V

SCT71401 Series

Application Waveforms(Continued)

Vin=Vout +1V, unless otherwise noted

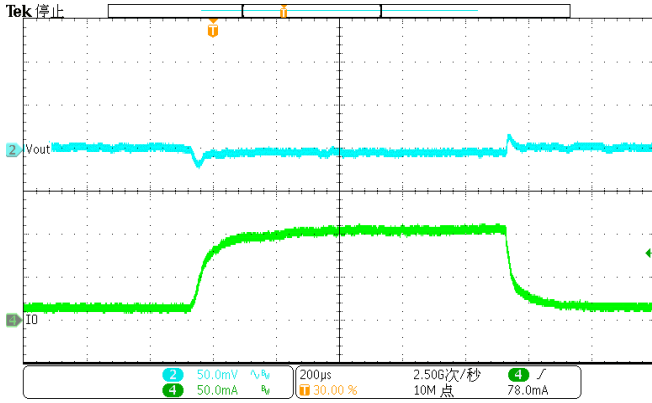

Figure 38. DC-DC Load Transient
(10mA-100mA),VOUT=5V

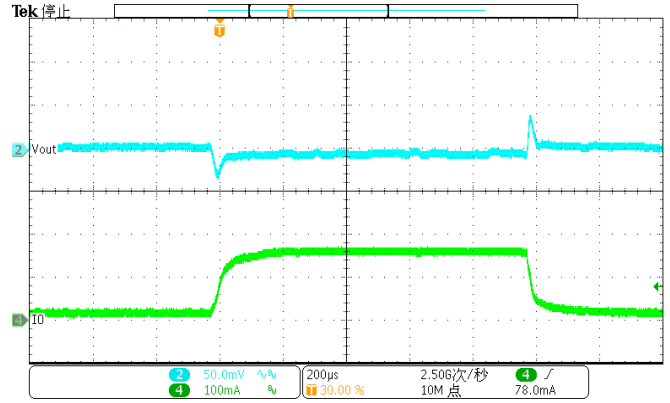

Figure 39. DC-DC Load Transient
(10mA-150mA),VOUT=5V

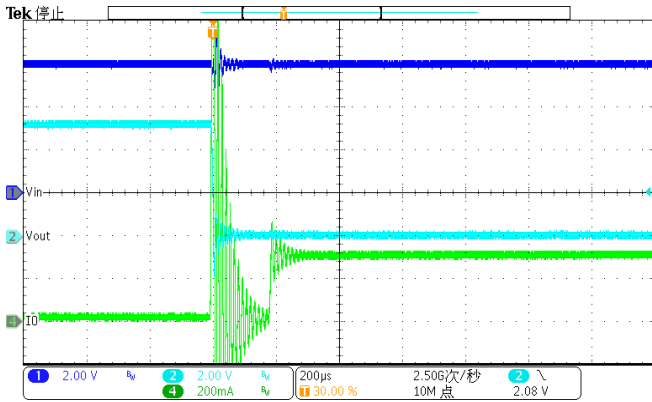

Figure 40. Enter Short Circuit Protection

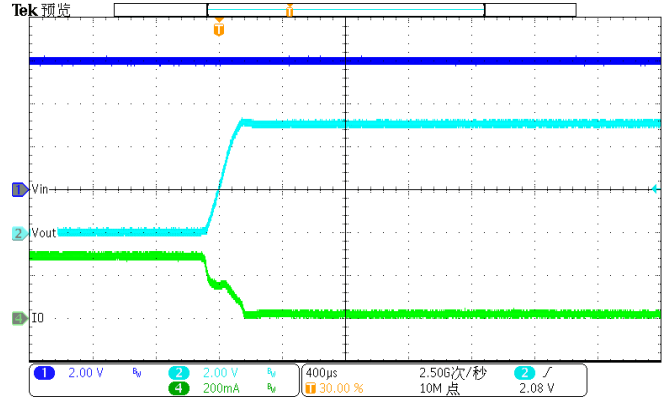

Figure 41. Exit Short Circuit Protection

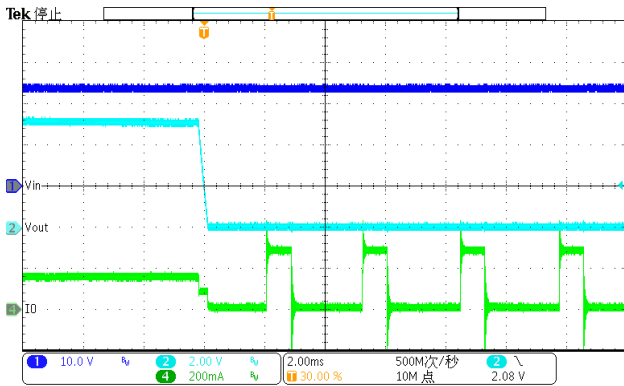

Figure 42. Enter Over Temperature Protection

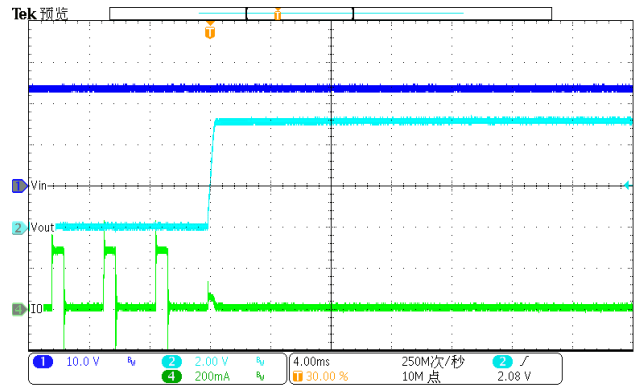

Figure 43. Exit Over Temperature Protection

Layout Guideline

Proper PCB layout is a critical for SCT71401's stability, transient performance and good regulation characteristics. For better results, follow these guidelines as below:

1. Both input capacitors and output capacitors must be placed as close to the device pins as possible.
2. It is recommended to bypass the input pin to ground with a 0.1μF bypass capacitor. The loop area formed by the bypass capacitor connection, V_{IN} pin and the GND pin of the system must be as small as possible.
3. It is recommended to use wide trace lengths or thick copper weight to minimize I×R drop and heat dissipation.
4. To improve the thermal performance of the device, and maximize the current output at high ambient temperature, SCT recommends spreading the copper under the thermal pad as far as possible and placing enough thermal vias on the copper under the thermal pad.
5. If using large electrolytic capacitor with high ESR resistor, SCT recommends adding a 10uF low ESR capacitor parallel connection with the large electrolytic capacitor.

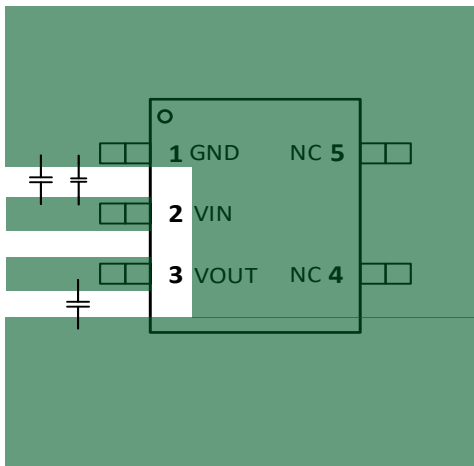

Figure 44. PCB Layout Example

SCT71401FxxTWDR

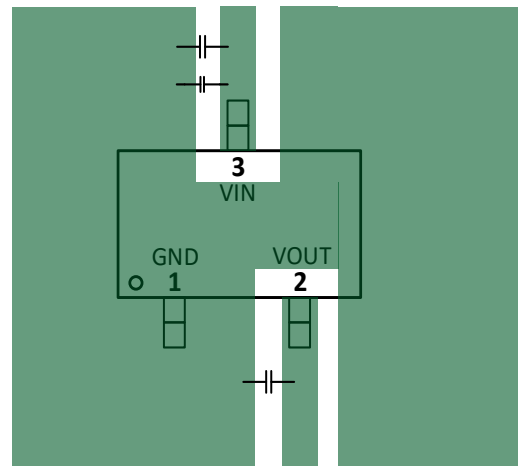

Figure 45. PCB Layout Example

SCT71401FxxTYDR

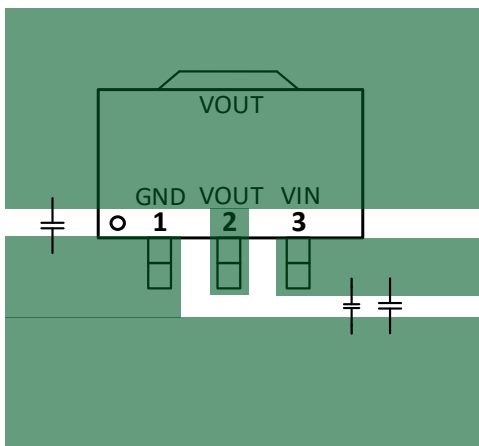
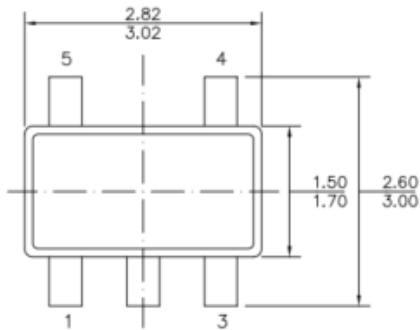

Figure 46. PCB Layout Example

SCT71401FxxTYFR

SCT71401 Series

PACKAGE INFORMATION



TOP VIEW

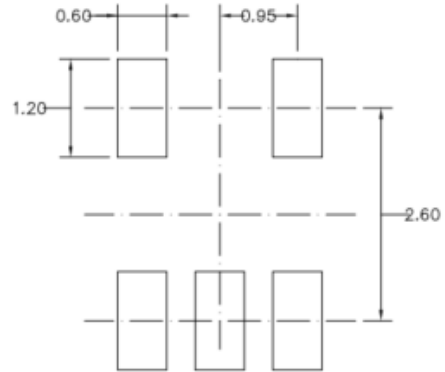

RECOMMENDED LAND PATTERN

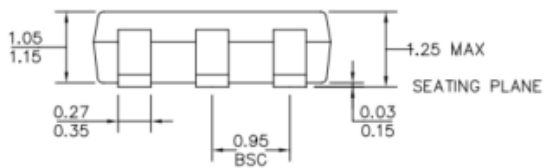

FRONT VIEW

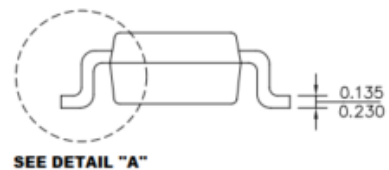

SIDE VIEW

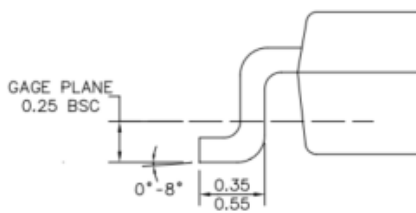

DETAIL A

NOTE:

- 1) ALL DIMENSIONS ARE IN MILLIMETERS.
- 2) PACKAGE LENGTH DOES NOT INCLUDE MOLD FLASH, PROTRUSION OR GATE BURR.
- 3) PACKAGE WIDTH DOES NOT INCLUDE INTERLEAD FLASH OR PROTRUSION.
- 4) LEAD COPLANARITY (BOTTOM OF LEADS AFTER FORMING) SHALL BE 0.10 MILLIMETERS MAX.
- 5) DRAWING CONFORMS TO JEDEC MO-193, VARIATION AA.
- 6) DRAWING IS NOT TO SCALE.

SOT23-5 Package Outline Dimensions

NOTE:

1. Drawing proposed to be made a JEDEC package outline MO-193 variation.
2. Drawing not to scale.
3. All linear dimensions are in millimeters.
4. Thermal pad shall be soldered on the board.
5. Dimensions of exposed pad on bottom of package do not include mold flash.
6. Contact PCB board fabrication for minimum solder mask web tolerances between the pins.

PACKAGE INFORMATION

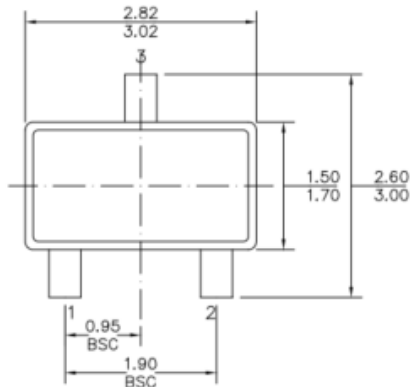

TOP VIEW

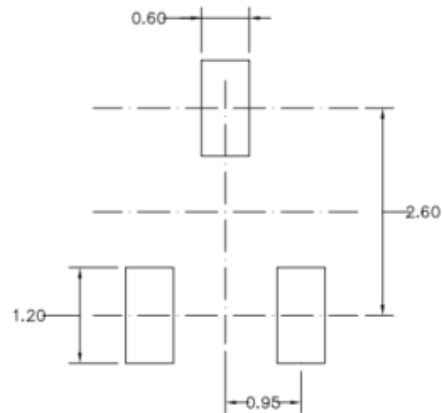

RECOMMENDED LAND PATTERN

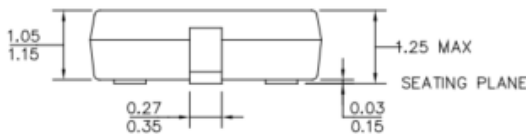

FRONT VIEW

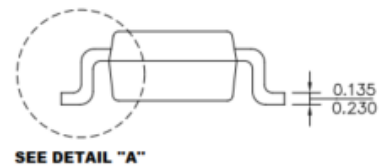

SIDE VIEW

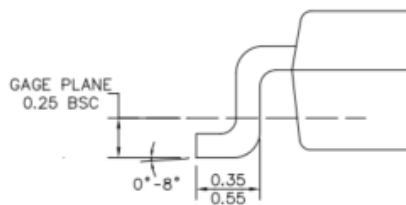

DETAIL A

NOTE:

- 1) ALL DIMENSIONS ARE IN MILLIMETERS.
- 2) PACKAGE LENGTH DOES NOT INCLUDE MOLD FLASH, PROTRUSION OR GATE BURR.
- 3) PACKAGE WIDTH DOES NOT INCLUDE INTERLEAD FLASH OR PROTRUSION.
- 4) LEAD COPLANARITY (BOTTOM OF LEADS AFTER FORMING) SHALL BE 0.10 MILLIMETERS MAX.
- 5) DRAWING CONFORMS TO JEDEC MO-193, VARIATION AA.
- 6) DRAWING IS NOT TO SCALE.

SOT23-3 Package Outline Dimensions

NOTE:

1. Drawing proposed to be made a JEDEC package outline MO-220 variation.
2. Drawing not to scale.
3. All linear dimensions are in millimeters.
4. Thermal pad shall be soldered on the board.
5. Dimensions of exposed pad on bottom of package do not include mold flash.
6. Contact PCB board fabrication for minimum solder mask web tolerances between the pins.

SCT71401 Series

PACKAGE INFORMATION

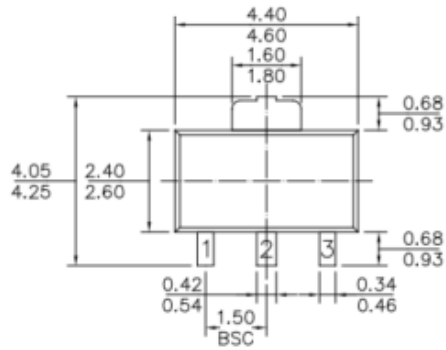

TOP VIEW

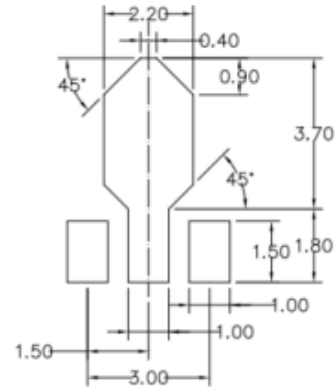

RECOMMENDED LAND PATTERN

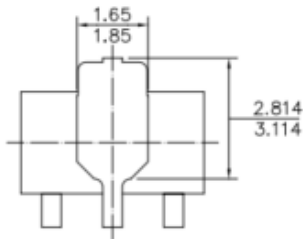

BOTTOM VIEW

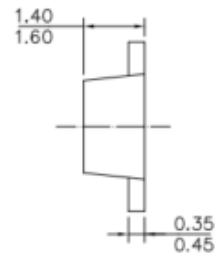

SIDE VIEW

NOTE:

- 1) ALL DIMENSIONS ARE IN MILLIMETERS.
- 2) JEDEC REFERENCE IS TO-243.
- 3) DRAWING IS NOT TO SCALE.

SOT89-3 Package Outline Dimensions

NOTE:

1. Drawing proposed to be made a JEDEC package outline MO-220 variation.
2. Drawing not to scale.
3. All linear dimensions are in millimeters.
4. Thermal pad shall be soldered on the board.
5. Dimensions of exposed pad on bottom of package do not include mold flash.
6. Contact PCB board fabrication for minimum solder mask web tolerances between the pins.

TAPE AND REEL INFORMATION

Orderable Device	Package Type	Pins	SPQ
SCT71401 Series	SOT23-5	5	3000

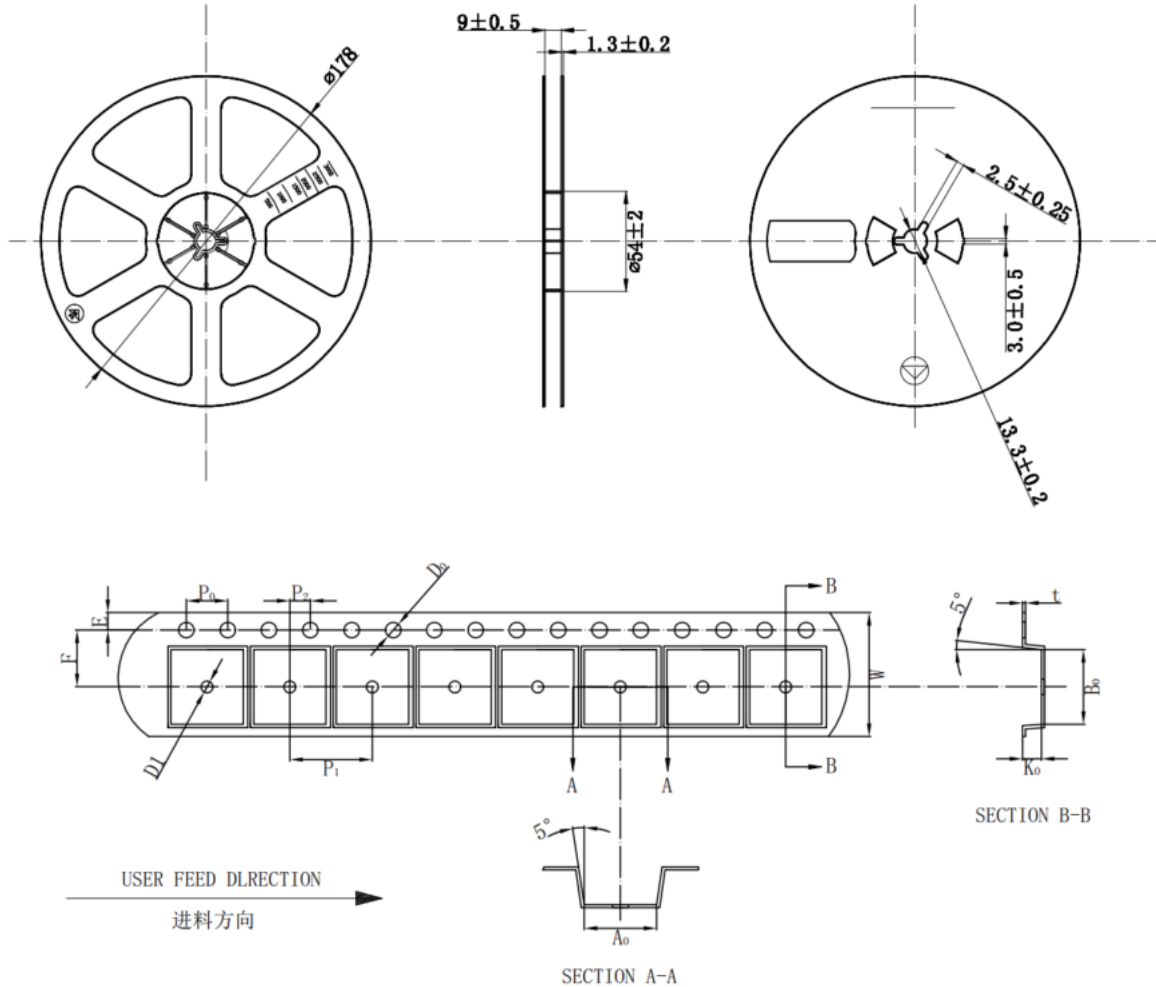

ITEM	W	A ₀	B ₀	K ₀	E	F	D1	D ₀	P ₀	P ₁	P ₂	t
MIN	7.80	3.15	3.25	1.28	1.65	3.45	—	—	3.90	3.90	1.95	0.20
NOM	8.00	3.25	3.30	1.38	1.75	3.50	1.00	1.50	4.00	4.00	2.00	0.25
MAX	8.20	3.35	3.40	1.48	1.85	3.55	1.10	1.60	4.10	4.10	2.05	0.30

- 备注:
- 任意10个齿轮的累计误差不超过±0.2mm;
 - 材料厚度以载带边缘测量为准;
 - 载带长度方向100mm距离的非平行度不可超过1mm; 超过250mm不计算累计误差;
 - 非指明, 公差范围为: ±0.1mm
 - A₀、B₀为型腔内侧最底部向上0.3mm处测量为准, K₀为内部深度;
 - 型腔外形凡未标明处倒角R为0.2-0.3;

NOTICE: The information in this document is subject to change without notice. Users should warrant and guarantee the third party Intellectual Property rights are not infringed upon when integrating Silicon Content Technology (SCT) products into any application. SCT will not assume any legal responsibility for any said applications.

SCT71401 Series

TAPE AND REEL INFORMATION

Orderable Device	Package Type	Pins	SPQ
SCT71401 Series	SOT23-3	3	3000

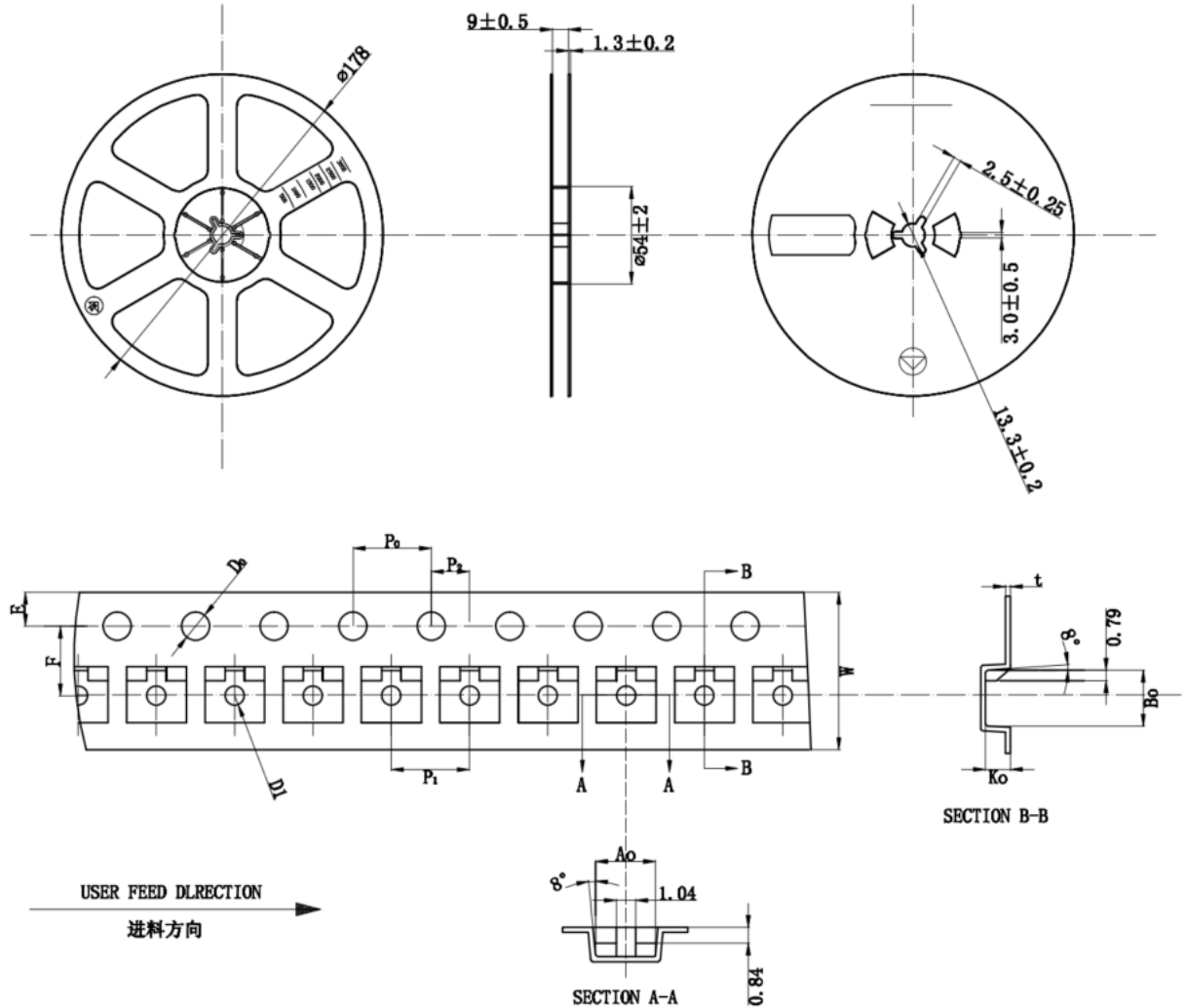

ITEM	W	A ₀	B ₀	K ₀	E	F	D1	D ₀	P ₀	P ₁	P ₂	t
MIN	7.90	3.08	3.18	1.22	1.65	3.45	—	—	3.90	3.90	1.95	0.20
NOM	8.00	3.18	3.28	1.32	1.75	3.50	1.00	1.50	4.00	4.00	2.00	0.25
MAX	8.30	3.28	3.38	1.42	1.85	3.55	1.10	1.60	4.10	4.10	2.05	0.30

备注:

- 任意10个齿轮的累计误差不超过±0.2mm;
- 材料厚度以载带边缘测量为准;
- 载带长度方向100mm距离的非平行度不可超过1mm; 超过250mm不计算累计误差;
- 非指明, 公差范围为: ±0.1mm
- A₀、B₀为型腔内侧最底部向上0.3mm处测量为准; K₀为内部深度;
- 型腔外形凡未标明处倒角R为0.2-0.3;

NOTICE: The information in this document is subject to change without notice. Users should warrant and guarantee the third party Intellectual Property rights are not infringed upon when integrating Silicon Content Technology (SCT) products into any application. SCT will not assume any legal responsibility for any said applications.

TAPE AND REEL INFORMATION

Orderable Device	Package Type	Pins	SPQ
SCT71401 Series	SOT89-3	3	3000

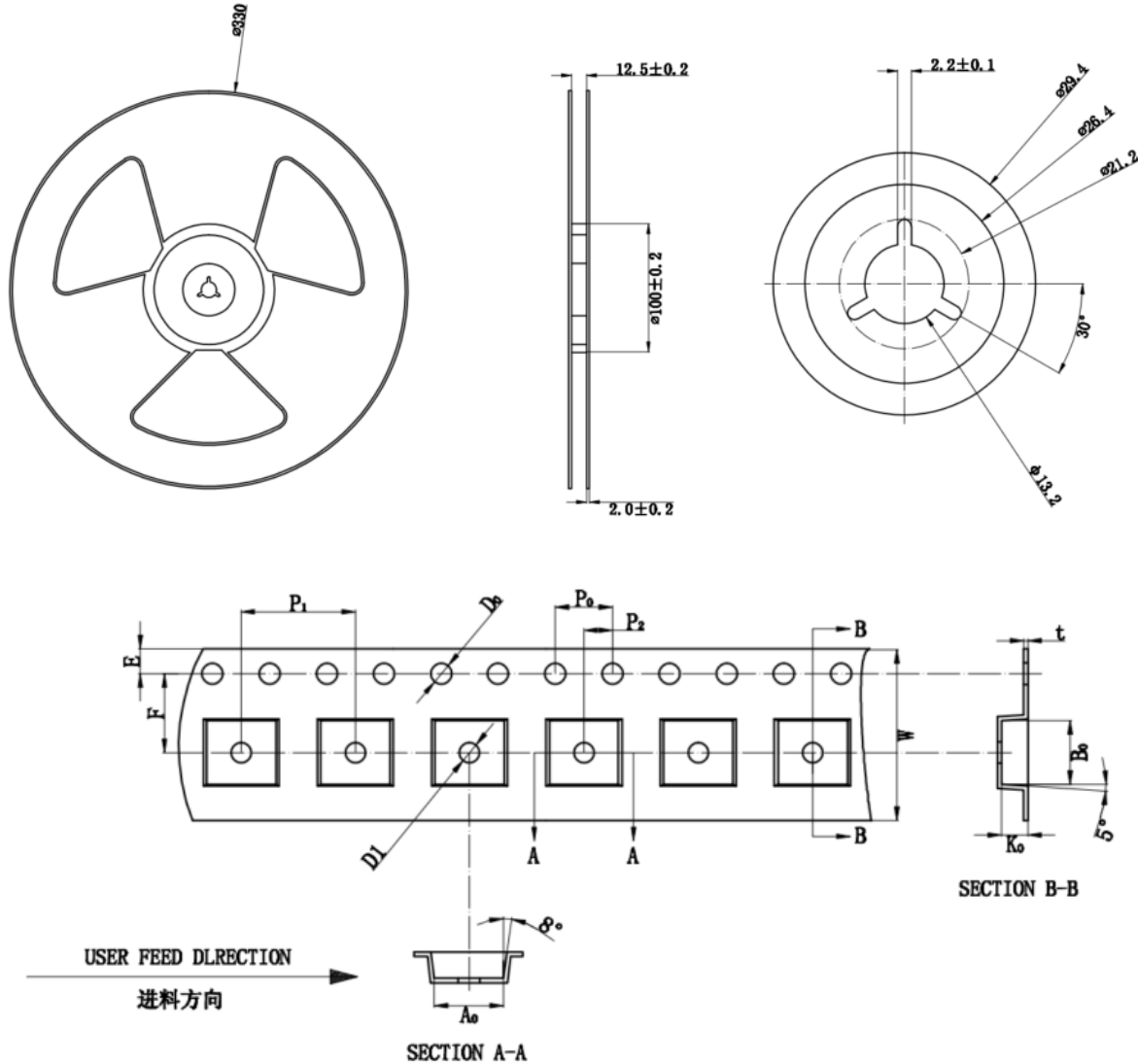

ITEM	W	A ₀	B ₀	K ₀	E	F	D ₁	D ₀	P ₀	P ₁	P ₂	t
MIN	11.80	4.80	4.40	1.75	1.65	5.45	—	—	3.90	7.90	1.95	0.20
NOM	12.00	4.90	4.50	1.85	1.75	5.50	1.50	1.50	4.00	8.00	2.00	0.25
MAX	12.20	5.00	4.60	1.95	1.85	5.55	1.60	1.60	4.10	8.10	2.05	0.30

备注:

- 任意10个齿轮的累计误差不超过±0.2mm;
- 材料厚度以载带边缘测量为准;
- 载带长度方向100mm距离的非平行度不可超过1mm; 超过250mm不计算累计误差;
- 非指明, 公差范围为: ±0.1mm
- A₀、B₀为型腔内侧最底部向上0.3mm处测量为准, K₀为内部深度;
- 型腔外形凡未标明处倒角R为0.2-0.3;

NOTICE: The information in this document is subject to change without notice. Users should warrant and guarantee the third party Intellectual Property rights are not infringed upon when integrating Silicon Content Technology (SCT) products into any application. SCT will not assume any legal responsibility for any said applications.